

Haier

User Manual

HW70-IM12929/S3/S8/S9
HW70-IM12929C/CS3/CS8/CS9
HW75-IM12929/S3/S8/S9
HW75-IM12929C/CS3/CS8/CS9
HW80-IM12929/S3/S8/S9
HW80-IM12929C/CS3/CS8/CS9



QR Code to directly chat with customer care executive.
(Customer Care WhatsApp No.: +91 8553049999)

Thank you for purchasing a Haier Product.

Please read these instructions carefully before using this appliance. The instructions contain important information which will help you get the best out of the appliance and ensure safe and proper installation, use and maintenance.

Keep this manual in a convenient place so you can always refer to it for the safe and proper use of the appliance.

If you sell the appliance, give it away, or leave it behind when you move house, make sure you also pass this manual so that the new owner can become familiar with the appliance and safety warnings.

Legend



Warning – Important Safety information



General information and tips



Environmental information

Disposal



Help protect the environment and human health. Put the packaging in applicable containers to recycle it. Help to recycle waste of electrical and electronic appliances. Do not dispose appliances marked with this symbol with the household waste. Return the product to your local recycling facility or contact your municipal office.



WARNING!

Risk of injury or suffocation!

Disconnect the appliance from the main supply. Cut off the main cable and dispose of it. Remove the door latch to prevent the children and pets to trap inside drum during non operation of machine for long time.

1-Safety information.....	3
2-Before Use	6
3-Functions	11
4-Programmes.....	14
5-Daily use.....	15
6-Eco-friendly washing.....	20
7-Maintenance.....	21
8-Troubleshooting.....	24
9-Technical data.....	27
10-After-Sale Service	28

1. Safety Information

Before switching on the appliance for the first time read the following safety hints!



WARNING!

Before first use

- ▶ Make sure there is no transit damage.
- ▶ Make sure all transit bolts are removed.
- ▶ Remove all packing material and keep out of reach of childrens.
- ▶ Handle the appliance always with atleast two persons because it is heavy in weight.

Daily use

- ▶ This appliance can be used by childrens aged from 8 years and above and persons with reduced physical, sensory or mental capabilities or lack of experience and knowledge if they have been given supervision or instructions concerning use of the appliance in a safe way and understand the hazards involved.
- ▶ Keep away from children under 3 years of age from the appliance unless they are constantly supervised.
- ▶ Childrens shall not play with the appliance.
- ▶ Do not let the children or pets come close to the appliance when the door of machine is open. Store washing agents away from the childrens.
- ▶ Pull up zips, fix loose threads and take care for small items to prevent laundry from being entangled. If necessary, use an appropriate bag or net.
- ▶ Do not start or use the appliance when you are barefoot or with wet or damp hands or feet.
- ▶ Do not cover or encase the appliance during operation or afterwards to avoid moisture or dampness to evaporate.
- ▶ Do not place heavy objects or sources of heat or damp cotton on the top of the appliance.
- ▶ Do not use or store flammable detergent or dry cleaning agent near to the appliance.
- ▶ Do not use any flammable sprays near to the appliance.
- ▶ Do not wash any garments treated with solvents in the appliance without having dried them in the air before wash.

1. Safety Information



WARNING!

Daily use

- ▶ Do not insert or remove the plug in presence of flammable gas.
- ▶ Do not wash foam rubber or sponge like materials.
- ▶ Do not wash any laundry which is polluted with flour.
- ▶ Do not open detergent drawer during any wash cycle.
- ▶ Do not press the door during the washing process as it gets hot.
- ▶ Do not open the door if the water level is visible over the port hole.
- ▶ Do not force the door to open after the washing process is ended. The door is fitted with a self-lock device and will open shortly.
- ▶ Switch off the appliance after wash programme and before doing any routine maintenance. Disconnect the appliance from the electrical supply to save electricity and for safety.
- ▶ Hold the plug when unplugging the appliance from electrical supply.

Maintenance/cleaning

- ▶ Make sure that children are supervised at the time of cleaning and routine maintenance.
- ▶ Disconnect the appliance from the electrical supply before doing any routine maintenance.
- ▶ Keep the lower part of the porthole clean. Open the door and the detergent drawer if appliance not in use to prevent odours.
- ▶ Do not use water spray or steam to clean the appliance.
- ▶ Replace a damaged supply cord only by the manufacturer or its service agent or similarly qualified persons in order to avoid any hazard.
- ▶ Do not try to repair the appliance by yourself. To repair the appliance, please contact our customer service.

Installation

- ▶ The appliance should be placed in a well ventilated place. Please ensure a location from which door shall be opens fully.
- ▶ Never install the appliance in a damp place, or in an area where is possibility of water leaks such as under or near a sink unit. In the event of a water leak, cut the power supply and dry the machine naturally.

1. Safety Information



WARNING!

Installation

- ▶ Install the appliance only where the temperature is above 5 °C.
- ▶ Do not place the appliance directly on a carpet, or close to a wall or furniture.
- ▶ Do not install the appliance in direct sunlight, or in the near of heat sources (e.g. stoves, heaters).
- ▶ Make sure that the electrical information on the nameplate agrees with the power supply. If not, contact an electrician.
- ▶ Do not use multi-plug adapters and extension board.
- ▶ Make sure that only delivered electric cable and hose set shall be used.
- ▶ Make sure that electrical cable and plug shall not be damaged, if yes, then it shall be replaced by an electrician.
- ▶ Use a separate earthed socket for the power supply which is easy accessible after installation. The appliance must be earthed.
- ▶ Make sure that the hose joints and connections are firm and there is no leakage.

Intended use

This appliance is intended for washing laundry only. Any time follow the instructions given on the label of each garment. It is not intended for commercial or industrial use.

Changes or modifications in the device are not allowed. Unintended use may cause hazards and loss of all warranty and liability claims.

2. Before Use

i Note :

Due to technical changes and different models, the illustrations in the following pictures may differ from your model.

2.1 Picture of appliance

Front side (Fig. 2-1):



- 1 Detergent/Softener drawer
- 2 Worktop
- 3 Control panel
- 4 Door
- 5 Filter cover
- 6 Adjustable feet

Rear side (Fig. 2-2):

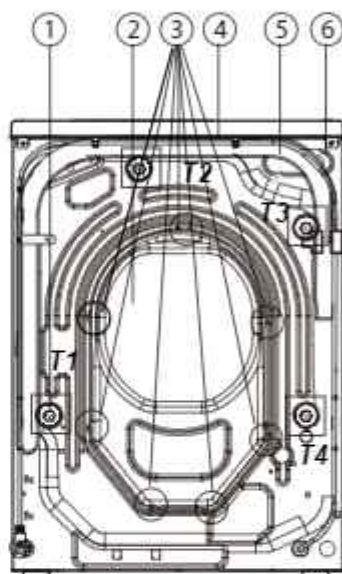

- 1 Transit bolts (T1-T4)
- 2 Backcover
- 3 Backcover screws 7 EA
- 4 Power cord
- 5 Water inlet valve
- 6 Drain hose

2.2 Accessories

Check the accessories and literature in accordance with this list (Fig. 2-3):



Inlet hose assembly

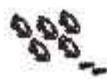

5 Blanking plugs+2 Screws



Drain hose bracket



User manual



Bottom plate

2. Before Use

2.3 Preparation

- ☒ Take the appliance out from the packaging.
- ☒ Remove all packing material including polystyrene base, keep them away from the childrens. When removing th packaging, water drops may be seen on plastic bag and porthole.This normal phenomenon results from water tests in the factory.



Note: Packaging disposal

Keep all the packaging materials away from the childrens and dispose it in an environmentally friendly manner.

2.4 Installation of bottom cover board

When opening the package, you will find a bottom cover (2-4.1) The board is used for reducing the noise.

1. Lay down the washing machine to it's back side, bottom side towards the operator.
2. Insert the Bottom cover into the cabinet, then fixed with 2 screws to the cabinet front side. Then set the machine upright again (Fig.2-4).

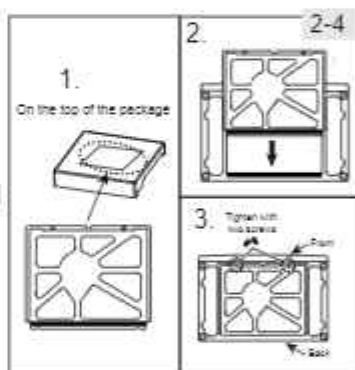

2.5 Dismantle the transit bolts

The transit bolts are designed to clamping the components inside the appliance during transportation to prevent inner damage.

1. Remove the transit bolts.
2. Fill the holes with blanking plugs (Fig.2-5).

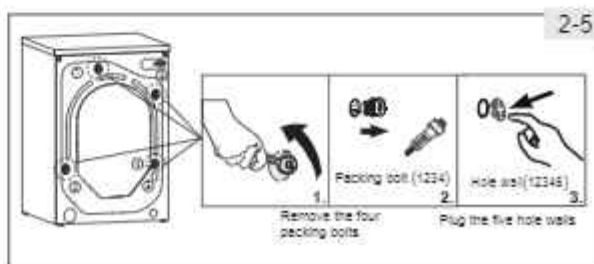

2. Before Use

i Note : Keep the transit bolts in a safe place

Keep the transit bolts in a safe place for later use. Whenever the appliance need to be moved to distant place, refix the transit bolts.

2.6 Moving the appliance

If the machine is to be moved to distant location, refix the transit bolts before moving the appliance to prevent damage.

1. Remove the blanking plugs.
2. Remove the back cover.
3. Insert the plastic spacers and the transit bolts.
4. Tighten the bolts with a spanner.
5. Refix the back cover.

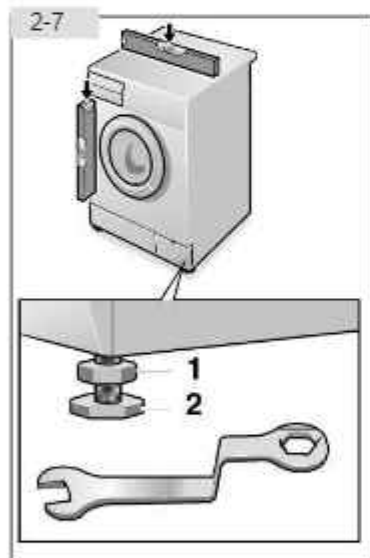

2.7 Aligning the appliance

Adjust all legs (Fig. 2-7) to achieve a complete level position. This will minimize vibrations and noise during use. It will also reduce wear and tear. We recommend to use a spirit level for levelling. Floor should be as stable and flat as possible.

1. Loose the locknut (1) by using a wrench.
2. Adjust the leg (2) by turning.
3. Tighten locknut (1) against the housing.

2. Before Use

2.8 Drain Water Connection

Fix the water drain hose properly to the piping. The hose has to reach a height between 80 to 100 cm at a point above the appliance bottom line. If possible, keep always drain hose fixed to the clip at the appliance back.



WARNING!

- ▶ Use only the supplied hose set for the connection.
- ▶ Never reuse old hose sets.
- ▶ Only connect to cold water supply.
- ▶ Before connection, check whether the water is clean and clear.

Following connections are possible:

2.8.1 Drain hose to sink

- ▶ Hang the drain hose with the U-support over the edge of a sink with adequate size (Fig. 2-8.1).
- ▶ Protect the U-support sufficiently.

2.8.2 Drain hose to waste water connection

- ▶ The internal diameter of the stand pipe with vent-hole must be minimum 40 mm.
- ▶ Put the drain hose for approx. 80 mm in the waste water pipe.
- ▶ Attach the U-support and secure it sufficiently (Fig. 2-8.2).

2.8.3 Drain hose to sink connection

- ▶ The junction must lie above the siphon
- ▶ A spigot connection is usually closed by a pad (A). That must be removed to prevent any disfunction (Fig. 2-8.3).
- ▶ Fix the drain hose with a clamp.

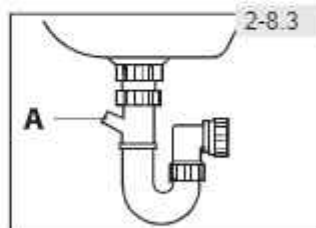
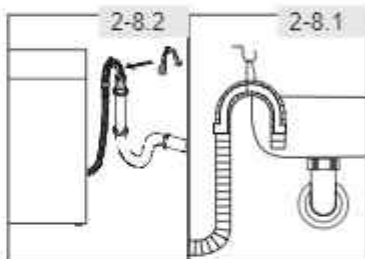

CAUTION!

- ▶ The Drain hose should not be submerged in water and should be securely fixed and leak-free. If the drain hose is placed on the ground or if the pipe is at a height of less than 80 cm, the washing machine will continuously drain while being filled (self-siphoning).
- ▶ Drain hose is not to be extended. If necessary contact service agent.

2. Before Use

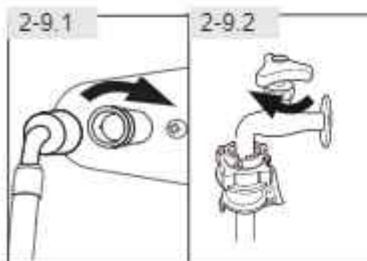

2.9 Fresh Water Connection

Make sure that the gaskets are inserted.

1. Connect the water inlet hose with the angled end to the appliance (Fig. 2-9.1). Tighten the joint by hand.
2. The other end connect to a water tap (Fig. 2-9.2).

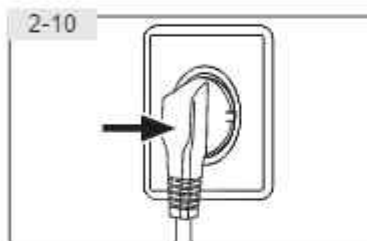

2.10 Electrical Connection

Before each connection check if:

- ▶ power supply, socket and fusing are appropriate to the nameplate.
- ▶ the power socket is earthed and no multi-plug or extension board are used.
- ▶ the power plug and socket are strictly according.

Put the plug into the socket (Fig. 2-10).



WARNING!

- ▶ Ensure always that all connections (power supply, drain and fresh water hose) are firm, dry and leak free.
- ▶ Take care these parts are never to be crushed, kinked, or twisted.
- ▶ If the supply cord is damaged, it must be replaced by the service agent (see warranty card) in order to avoid a hazard.



Note: Hygiene

After each installation or long periods of disuse, before first use and for regular maintenance run the "Self Clean" programme with no load and small amount of detergent in "detergent drawer" compartment (2) or with special machine cleaner to remove possibly residues.

3. Functions

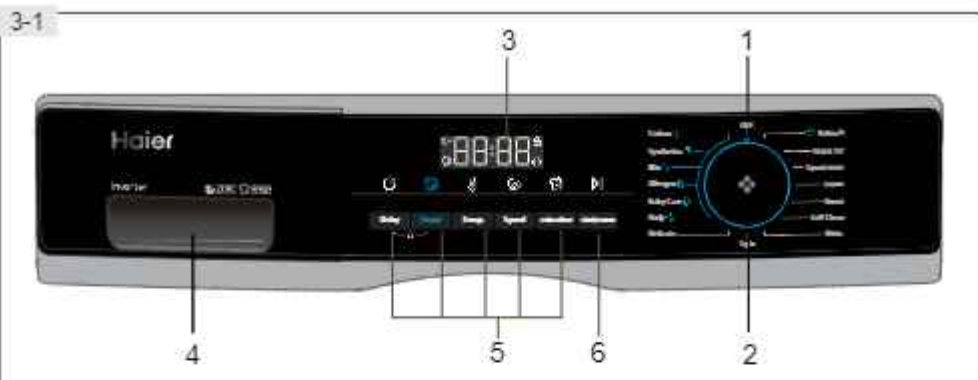

1 OFF

3 Display

5 Function buttons

2 Programme selector

4 Detergent / Softener drawer

6 "Start/Pause" button

Note : Acoustic signal

In following cases an acoustic signal sounds:

- when pressing a button
- at the end of programme
- in case of failures

The acoustic signal can be deselected if necessary; see DAILY USE.

3-2



3.1 OFF

Turn the knob to any position (except "OFF") to start the machine. Turn the knob to the OFF position to shut down the machine (Fig.3-2).

3-3



3.2 Programme selector

By turning the knob (Fig. 3-3), one of programme (except OFF) can be selected out of 15.

3-4



3.3 Display

The display (Fig. 3-4) shows following information:

- Washing time
- End time delay
- Steam washing
- Door lock
- Child lock

3. Functions

3.4 Detergent drawer

Two compartments can be seen after opening the drawer (Fig. 3-5):

1. Compartment 1: Power or Liquid detergent for programme.
2. Compartment 2: Softener, Conditioning agent etc. The recommendation on the type of detergents is suitable for the various washing temperatures, please refer the manual.

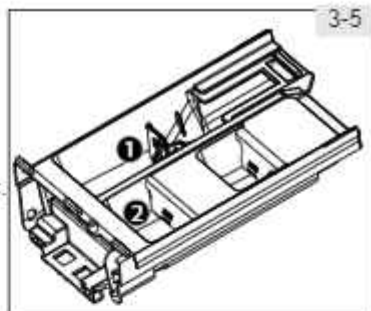

3.5 Function buttons

The function buttons (Fig. 3-6) enable additional options in the selected programme before programme starts. The related indicators are displayed.

If a button has multiple options, the desired option can be selected by touching the button sequentially.

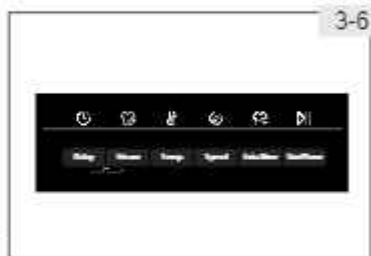

Note: Factory settings

To get best results in each programme Haier has well defined specific default settings. If there is no special requirement, default settings are recommended.

3.5.1-Function button "Delay"

Press this button (Fig.3-7) to start the programme with a delay. End time delay could be increase in steps of 30 minutes from 0.5-24h. When you select the delay, the total time will default longer than the programme run time. For example, display off 6:30 means end of programme cycle will be in 6 hours and 30 minutes. Press "Start/Pause" button to activate the time delay.



3.5.2-Function button "Temp."

Press this button (Fig. 3-9) to change the washing temperature of the programme. If no value is illuminated, the water will not be heated.



3. Functions



3.5.3 Function button "Speed"

Press this button (Fig. 3-9) to change or deselect the spin of the programme. If no value is illuminated, the laundry will not spin.



3.5.4 "Extra Rinse" button

Press this button (Fig. 3-10) to rinse the laundry more intense with fresh water. This is recommended for people with sensitive skin.

By touching the button several times, 0 to 2 additional cycles can be selected. They will appear in the display with P--0/P--1/P--2.

Note: Liquid detergent

If using liquid detergent, it is not recommended to activate the end time delay.



3.5.5 "Steam" button

Press this button (Fig. 3-11) to select the steam program, then the current program temperature value will be changed to the maximum allowed value. The maximum temperature value can be viewed on the programme table in the manual. You can select if you require this function when programmes "Cotton, Synthetics, Mix, Baby care, Allergen, Daily" are used. The icon will light up when using the steam wash function.



3.6 "Start/Pause" button

Press this button (Fig. 3-12) gently to start or interrupt the currently displayed programme.



3.7 Child lock

Press button "Delay" and "Steam" (Fig. 3-13) buttons for 3 seconds simultaneously for activating child lock function. For unlocking please touch again those two buttons. The child lock indicator lights up when the child lock works. This feature is optional when the machine is running.



The display shows "c lol" (Fig. 3-14) if a button will be pressed that means the child lock is activated.

4. Programmes

o Optional, /No

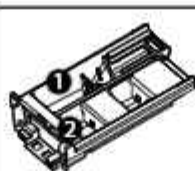

Detergent compartments :

- ❶ For Detergent
- ❷ For Softener or care product

Programme	Max. load in kg	Temperature in °C		▼ ▼		Fabric type	Preset spin speed in rpm	Function		
		Max. range	Preset	1	2			Steam	Additional Rinse	Delay
Cotton	7/7.5/8	90	30	o	o	Cotton	1000	o	o	o
Mix	3.5/4	60	30	o	o	Lightly soiled mixed-laundry of cotton and synthetic	1000	o	o	o
Synthetics	3.5/4	60	30	o	o	Synthetic or mixed fabric	1000	o	o	o
Babycare	3.5/4	90	40	o	o	Cotton/ synthetic	1000	o	o	o
Allergen	3.5/4	90	60	o	o	Cotton	1000	o	o	o
Daily	3.5/4	60	30	o	o	Cotton/ synthetic	1000	o	/	o
Jeans	1/1	40	30	o	o	Machine-washable fabric made of wool or with wool content	800	/	o	o
Delicate	2/2	30	30	o	o	Delicate laundry and silk	600	/	/	o
Refresh	/	/	/	/	/	Cotton/ synthetics	/	/	/	/
Quick 15	1/1	40	/	o	o	Cotton/ synthetics	1000	/	o	o
Spin	7/8	/	/	/	/	Non-fragile fabric	1000	/	/	/
Self Clean	/	/	/	/	/	/	/	/	/	/
Sportswear	2/2	40	20	o	o	Sport	800	/	/	o
Wool	2/2	60	30	o	o	Shirts	1000	/	o	o
Duvet	2/2	/	/	o	o	Duvet	/	/	/	/

1)*: Water is not heated up.

Choose 90°C wash temperature only for special hygienic requirements.

2) Only one piece of adult or bulky clothing can be washed, and up to three pieces of children's clothing.

3) Reduce detergent amount because programme duration is short.

4) Do not use detergent instead of use a special machine cleaner.

5. Daily Use

5.1 Power supply

Connect the power cord to the power supply (220V~/50Hz; Fig. 5-1). Please refer also section "BEFORE USE".

5.2 Water connection

- ▶ Before connecting the water inlet pipe, check the cleanliness and clarity of the water inlet.
- ▶ Turn on the tap (Fig. 5-2).

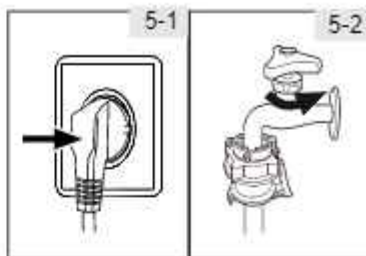

Note: Tightness

Before use check for leakage in the joints between the tap and the inlet hose by turning on the tap.

5.3 Preparing laundry

- ▶ Sort out clothes according to fabric (cotton, synthetics, wool or etc.) and how dirty they are (Fig. 5-3). Pay attention to the care labelling of washing labels.
- ▶ Separate white clothes from coloured ones. Wash coloured textiles first by hand to check if they fade then run.
- ▶ Empty pockets (keys, coins, etc.) and remove harder decorative objects (e.g. brooches).
- ▶ Garments without hems, delicates and finely woolen textile such as fine curtains are to be put into a wash bag to care (hand or dry cleaning would be better).
- ▶ Close zippers, fastener and hooks. Make sure that the buttons are sewn tightly.
- ▶ Place sensitive items like laundry without firm hems, delicate, underwear, and small items such as socks, belts etc in a wash bag.
- ▶ Unfold large pieces of fabric such as bed sheets, bedspreads etc.
- ▶ Turn jeans, printed, decorated, color intensive tiles inside out. (possibly wash separately)



CAUTION!

Non-textile, as well as small, loose or sharp-edged items may cause malfunctions and damage of clothes and appliance.

5. Daily Use

Care chart

Washing		
 Washable up to 95°C normal process	 Washable up to 60°C normal process	 Washable up to 60°C mild process
 Washable up to 40°C normal process	 Washable up to 40°C mild process	 Washable up to 40°C very mild process
 Washable up to 30°C normal process	 Washable up to 30°C mild process	 Washable up to 30°C very mild process
 Wash by hand max. 40°C	 Do not wash	
Bleaching		
 Any bleaching allowed	 Only oxygen/non-chlorine	 Do not bleach
Drying		
 Tumble drying possible normal temperature	 Tumble drying possible lower temperature	 Do not tumble dry
 Line drying	 Flat drying	
Ironing		
 Iron at a maximum temperature up to 200°C	 Iron at a medium temperature up to 150°C	 Iron at a low temperature up to 110°C without steam (Steam ironing may cause irreversibility damage)
 Do not iron		
Professional Textile Care		
 Dry cleaning in tetrachloroethene	 Dry cleaning in hydrocarbons	 Do not dry clean
 Professional wet clean	 Do not professional wet clean	

5.4 Loading the appliance

- ▶ Put the laundry in the drum piece by piece.
- ▶ Don't overload. Note the different maximum load according to programmes. Rule of thumb for maximum load : Check if you can put a hand upright on top of the load.
- ▶ Close the door carefully. Make sure that no pieces of laundry are pinched.

5. Daily Use

5.5 Selecting detergent

- ▶ Washing efficiency and performance is determined by used detergent quality.
- ▶ Use only machine wash approved detergent.
- ▶ If needed use specific detergents, e.g. synthetic and woolen fabric.
- ▶ Use detergent as per manufacturer recommendations.
- ▶ Do not use dry cleaning agents such as trichloroethylene and similar products.

Choose the best detergent

Programme	Kind of detergent				
	Universal	Colour	Delicate	Special	Softener
Cotton	√	√	-	-	√
Wool	√	√	-	-	√
Baby Care	-	-	√	√	√
Duvet	-	-	√L	√	o
Delicate	-	-	√	√	√
Synthetics	-	√	-	-	√
Self Clean	-	-	-	√	-
Jeans	√L	√L	-	-	√
Mix	√L	√	-	-	√
Quick 15'	√L	√L	-	-	√
Sportswear	-	-	√	√	√
Refresh	-	-	-	-	-
Spin	-	-	-	-	-
Allergen	-	-	√	√	√
Daily	√	√	-	-	√

L = gel/liquid detergent P = powder detergent O = optional - = no
 √ = Recommended

If using liquid detergent, it is not recommended to activate the time delay.

We recommend to use :

- ▶ Laundry powder: 20°C to 90°C* (best use: 40-60°C).
- ▶ Color detergent: 20°C to 60°C (best use: 30-60°C).
- ▶ Wool/delicate detergent: 20°C to 30°C (best use: 20-30°C).

* Choose 90°C wash temperature only for special hygienic requirements.

 It is better to use less or free suds detergent powder.

5. Daily Use

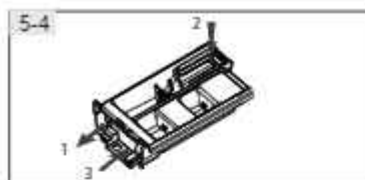

5.6 Adding detergent

1. Slide out the detergent drawer.
2. Put the required detergents into the corresponding compartments (Fig. 5-4).
3. Push back the drawer gently.

i Note:

- ▶ Remove detergent residues before next wash cycle from the detergent drawer.
- ▶ Do not overuse detergent or softener.
- ▶ Please follow the instruction on the detergent package.
- ▶ Always fill the detergent just before the beginning of the wash cycle.
- ▶ Concentrated liquid detergent should be diluted before adding into compartment 2.
- ▶ The best use of liquid detergent is by using a dosing ball.
- ▶ Do not use liquid detergent, if "end time delay" is selected.
- ▶ Carefully choose the programme settings according to the care symbols on all laundry labels and according to the programme table.



5.7 Switch on the appliance

Turn the knob to any position (except OFF) to start the machine. Turn the knob to the OFF position to shut down the machine (Fig. 5-5).



5.8 Select a programme

To get the best washing results, select a programme which fits the degree of soiling and sort of laundry type.

Turn the programme knob (Fig.5-6) to select the right programme.

i Note: Odour removal

Before first use we recommended to run programme Self Clean with no load and small amount of detergent in detergent drawer compartment (2) or special machine cleaner to remove possibly corruptive residues.

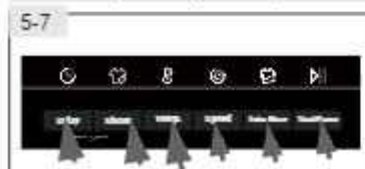

5.9 Add individual selections

Select required options and settings (Fig 5-7); refer to "CONTROL PANEL"

5. Daily Use

5.10 Start wash programme

Press "Start/Pause" button (Fig.5-8) to start. Appliance operates according to present settings. Changes are only possible by cancelling the programme.



5.11 Interrupt / cancel wash programme

To interrupt a running programme press gently "Start/Pause". The LED in the button is flashing. Press it again to resume operation.

To cancel a running programme and all its individual settings:

1. Press "Start/Pause" button to interrupt the running programme.
2. Turn the knob to select a new programme and start it.

5.12 After washing

i Note: Door lock

- ▶ For safety purpose the door is locked partially during the washing cycle. It is only possible to open the door at the end of programme or after the programme was cancelled correctly (see description above).
- ▶ In case of high water level, high water temperature and during spinning it is not possible to open the door. **Lock** is displayed.

1. At programme cycle end **End** is displayed.
2. The appliance switches off automatically.
3. Remove laundry as soon as possible to go easy on it and to prevent more wrinkling.
4. Turn off the water supply.
5. Unplug the power cord.
6. Open the door to prevent formation of moisture and odours. Let it open while not used. Minutes before starting the programme or at the end of programme. The display switches off.

i Note: Standby mode / energy-saving mode

The switched on appliance will go into standby mode if it will not be activated within 2 minutes before starting the programme or at the end of programme. The display switches off and saves energy.

5.13 Activate or deactivate the buzzer

The acoustic signal can be deselected if necessary:

1. Switch on the appliance.
2. Select the "Spin" programme.
3. Press the "Extra rinse" button "Temp." button and "Steam" button at the same time for about 3 seconds. "**bEEP OFF**" will be displayed and the buzzer will be deactivated. For activating the buzzer, press those three buttons at the same time again, then "**bEEP On**" will be displayed.

6. Eco-friendly washing



Environmentally responsible use

- ▶ To achieve best use of energy, water, detergent and time you should use the recommended maximum load size.
- ▶ Do not overload (hand width clearance above laundry).
- ▶ For slightly solid laundry select the "Quick 15" programme.
- ▶ Apply exact dosages of each washing agent.
- ▶ Choose the lowest adequate washing temperature - modern detergents are efficiently cleaning below 60 °C.
- ▶ Raise default settings only due to heavy staining.
- ▶ Select max. spinning speed if a domestic cloth is used.

7. Maintenance

7.1 Cleaning the detergent drawer

Take always care there are no detergent residues. Clean the drawer regularly (Fig. 7-1):

1. Pull out the drawer until it stops.
2. Press there lease button and remove the drawer.
3. Flush the drawer with water until it is clean and insert the drawer back in the appliance.

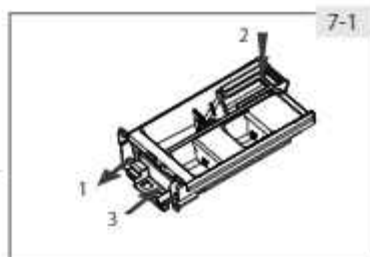

7.2 Cleaning the machine

- ☒ Unplug the machine during cleaning and maintenance.
- ☒ Use a soft cloth with soap liquid to clean the machine case (Fig. 7-2) and rubber components.
- ☒ Do not use organic chemicals or corrosive solvents.



7.3 Water inlet valve and inlet valve filter

To prevent blockage of water supply by solid substances like lint clean regularly the inlet valve filter

- ☒ Unplug the power cord and turn off the water supply.
- ☒ Unscrew the water inlet hose at the back of the appliance as well as on the tap (Fig.7-3.1).
- ☒ Remove the filters and flush them with water and a brush (Fig.7-3.2).
- ☒ Insert the filter and install the inlet hose.

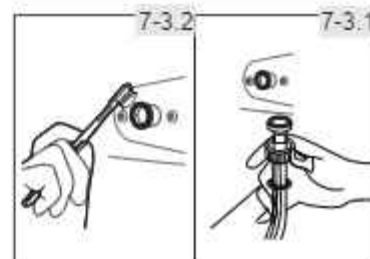

7.4 Cleaning the drum

- ☒ Remove accidentally washed metal parts such as pins, coins, etc. from the drum (Fig.7-4) because they cause rust, stains and damage.
- ☒ Use a non-chloride cleaner for removing rust stains. Observe the warning hints of the cleaning agent manufacturer.
- ☒ Do not use any hard objects or steel wool for cleaning.



Note: Hygiene

For regular maintenance we recommend to run programme Self Clean with no load in order to remove possible corruptive residues quarterly. Add a small amount of detergent in washing agent compartment (2) - or use a special machine cleaner.

7. Maintenance

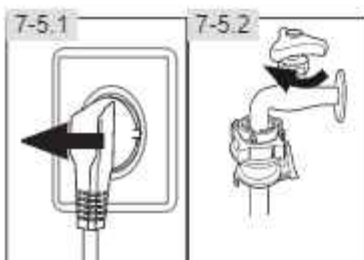

7.5 Long periods of disuse

If the appliance is left idle for a longer period:

1. Pull out the electrical plug (Fig. 7-5.1).
2. Turn off water supply (Fig. 7-5.2).
3. Open the door to prevent formation of moisture and odours. Let door open while not used.

Before next usage check carefully power cord, water inlet and drain hose. Make sure everything is properly installed and without leakage.

Note: Hygiene

After long periods of disuse we recommended to run programme Self Clean with no load and small amount of detergent in washing agent compartment (2) or special machine cleaner to remove possibly corruptive residues.

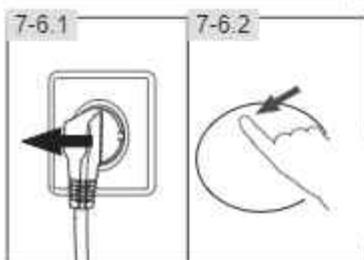

7.6 Pump filter

Clean the filter once a month and check the pump filter for instance if the appliance:

- ▶ Doesn't drain the water.
- ▶ Doesn't spin.
- ▶ Cause unusual noise while running.



WARNING!

Scalding Risk! Water in the pump filter can be very hot! Before any action please ensure water has cooled down.

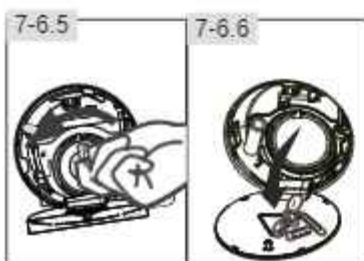
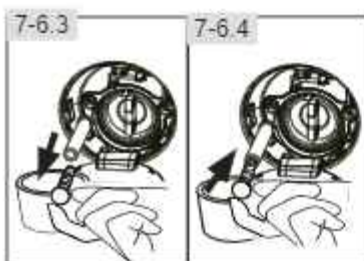

1. Turn off and unplug the machine (Fig. 7-6.1).
2. Open service flap. You can either use a coin or a screw driver (Fig. 7-6.2).
3. Provide a flat container to catch leach water (Fig. 7-6.3). There could be bigger amounts.
4. Pull the drain hose out and hold its end above the container (Fig. 7-6.3).
5. Take the sealing plug out of the drain hose (Fig. 7-6.3).
6. After complete drainage close drain hose (Fig. 7-6.4) and push it back into the machine.
7. Unscrew and remove the pump filter (Fig. 7-6.5).
8. Remove contaminants and dirt (Fig. 7-6.6).

7. Maintenance

- Clean carefully pump filter, e.g. using running water(Fig.7-6.7).
- Refix it thoroughly(Fig.7-6.8).
- Close service flap.

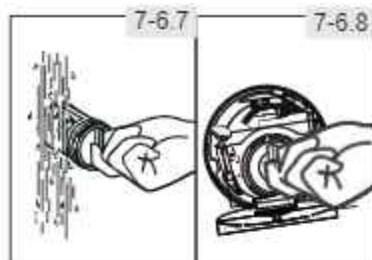

CAUTION!

- ▶ Pump filter sealing has to be clean and unhurt.If the lid is not full tightened, water can escape.
- ▶ The filter must be in place, or it may lead to leakage.

8. Troubleshooting

Many occurring problems could be solved by yourself without specific expertise. In case of a problem please check all shown possibilities and follow below instructions before you contact an after sales service. See CUSTOMER SERVICE.



WARNING!

- ⊗ Before maintenance, deactivate the appliance and disconnect the mains plug from the mains socket.
- ⊗ Electrical equipment should be serviced only by qualified electrical experts, because improper repairs can cause considerable consequential damages.
- ⊗ A damaged power cable should only be replaced by the manufacturer, its service agent or similarly qualified persons in order to avoid a hazard.

8.1 Information codes

Following codes are displayed only for information referring to the washing cycle. No measures must be performed.

Code	Message
1:25	The remaining wash cycle time will be 1 hour and 25minutes.
6:30	The remaining wash cycle time including chosen end-time delay will 6 hours and 30 minutes.
End	The washing cycle is finished. The appliance shuts off automatically.
Child	Function child lock is activated.
Lock	Door is closed because of high water level, high water temperature or spinning cycle.
BEEP On	The buzzer is deactivated.
BEEP Off	The buzzer is activated.

8.2 Troubleshooting with display code

Problem	Cause	Solution
Err FERR	• Drainage error, water is not fully drained within 6 minutes.	• Clean pump filter. • Check drain hose installation.
E2	• Lock error.	• Shut the door properly.
E4	• Water level not reached after 30 minutes, at the latest. • Drain hose is self-syphoning.	• Make sure that tap is fully opened and water pressure is normal. • Check drain hose installation.
E8	• Water protective level error.	• Contact the service agent
E3	• Temperature sensor error.	• Contact the service agent
E4	• Heating error.	• Contact the service agent

8. Troubleshooting

Problem	Cause	Solution
E8	• Motor error.	• Contact the service agent
EE8 EE8 or EE2	• Abnormal communication error.	• Contact the service agent
U88	• Unbalanced load error.	• Check and balance laundry load in the drum. Reduce the load.
ER	• Water level sensor error.	• Contact the service agent

8.3 Troubleshooting without display code

Problem	Cause	Solution
Washing machine fails to operate.	<ul style="list-style-type: none"> • Programme is not yet started. • Door is not properly closed. • Machine has not been switched on. • Power failure. • Child lock is activated. 	<ul style="list-style-type: none"> • Check programme and start it. • Close the door properly. • Switch the machine on. • Check power supply. • Deactivate child lock.
Washing machine will not be filled with water.	<ul style="list-style-type: none"> • No water. • Inlet hose is kinked. • Inlet hose filter is blocked. • Water pressure is less than 0.03 MPa. • Door is not properly closed. • Water supply failure. 	<ul style="list-style-type: none"> • Check water tap. • Check inlet hose. • Unblock inlet hose filter. • Check water pressure. • Close the door properly. • Ensure the water supply.
Machine is draining while being filled.	<ul style="list-style-type: none"> • Height of drain hose is below 80 cm. • Drain hose end could reach into water. 	<ul style="list-style-type: none"> • Make sure that drain hose is properly installed. • Make sure the drain hose is not in water.
Drainage failure.	<ul style="list-style-type: none"> • Drain hose is blocked. • Pump filter is blocked. • Drain hose end is higher than 100 cm above floor level. 	<ul style="list-style-type: none"> • Unblock drain hose. • Clean pump filter. • Make sure the drain hose is properly installed.
Strong vibration while spinning.	<ul style="list-style-type: none"> • Not all transportation bolts have been removed. • Appliance has no solid position. • Machine load is not correct. 	<ul style="list-style-type: none"> • Remove all transportation bolts. • Ensure solid ground and a levelled position. • Check load weight and balance.
Operation stops before completing wash cycle.	<ul style="list-style-type: none"> • Water or electric failure. 	<ul style="list-style-type: none"> • Check power and water supply.
Operation stops for a period of time.	<ul style="list-style-type: none"> • Appliance displays error code. • Problem due to load pattern. • Programme performs soaking cycle. 	<ul style="list-style-type: none"> • Consider display codes. • Reduce or adjust load. • Cancel programme and restart.
Excessive foam floats drum and/or detergent drawer.	<ul style="list-style-type: none"> • Detergent is not appropriate. • Excessive use of detergent. 	<ul style="list-style-type: none"> • Check detergent recommendations. • Reduce amount of detergent.

8. Troubleshooting

Problem	Cause	Solution
Automatic adjustment of washing time.	<ul style="list-style-type: none">• Washing programme duration will be adjusted.	<ul style="list-style-type: none">• This is normal and doesn't affect function.
Spinning fails.	<ul style="list-style-type: none">• Unbalance of laundry.	<ul style="list-style-type: none">• Check machine load and laundry and run a spinning programme again.
Unsatisfactory washing result.	<ul style="list-style-type: none">• Degree of pollution does not agree with selected programme.• Detergent quantity was not sufficient.• Maximum load has been exceeded.• Laundry was unevenly distributed in the drum.	<ul style="list-style-type: none">• Select an other programme.• Choose the detergent according to the degree of pollution and according to manufacturer specifications.• Reduce loading.• Loose the laundry.
Washing powder residues are on the laundry.	<ul style="list-style-type: none">• Insoluble particles of detergent can remain as white spots on the laundry.	<ul style="list-style-type: none">• Perform extra rinse.• Try to brush the points from the dry laundry.• Choose an other detergent.
Laundry has grey patches.	<ul style="list-style-type: none">• Caused by fats such as oils, creams or ointments.	<ul style="list-style-type: none">• Pretreat the laundry with a special cleaner.



Note: Foam formation

If too much foam is inspected during spin cycle, motor stops and drain pump will be activated for 90 seconds. If that elimination of foam fails up to 3 times, programme ends without spinning.

Should the error messages reappear even after the taken measures, switch off the appliance, disconnect the power supply and contact the customer service.

8-4

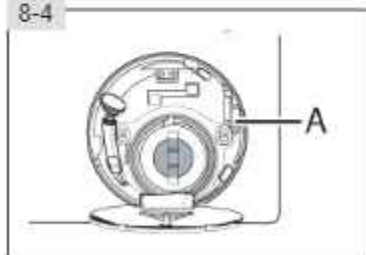

8.4 In case of power failure

The current programme and its setting will be saved. When power supply is restored operation will be resumed.

In case of power failure during programme run door opening is mechanically blocked. If the laundry is to be removed, the water level must not be visible in the glass door. -Danger of scalding!

- ▶ Lower the water level according to step 1 to 6 of chapter CARE AND CLEANING (PUMP FILTER).
- ▶ Pull lever (A) beneath service flap (Fig.8-4) until door is unlocked by a gentle click.
- ▶ Fix all parts and close the service flap.

9. Technical data

9.1 Additional technical data

Model Name	HW70-IM12929/S3/S8/S9, HW70-IM12929C/CS3/CS8/CS9, HW75-IM12929/S3/S8/S9, HW75-IM12929C/CS3/CS8/CS9, HW80-IM12929/S3/S8/S9, HW80-IM12929C/CS3/CS8/CS9
Dimension Height	850mm
Width	595mm
Depth	468mm
Power supply	220V~/50Hz
Current	10A
Max. power	1800W
Water Pressure	0.03MPa≤P ≤1MPa
Net weight	53.5kg
Max. spin speed	1200rpm

10. After-Sale Service

If after checking the trouble-shooting part, the problem is not solved, Please check the Warranty Card included in the product.

E-waste Guideline Manual



Introduction

We at Haier in our continuous efforts of making a future better adopted eco-friendly practices and procedures. We acting towards our social, moral and statutory responsibility towards the environment and sustainable development have pledged to recycle electronic items, such as TV/LED/LCD, refrigerator, washing machine, etc. that are no longer useful. Haier is stepping towards leading a more conservation and optimization of resources and thereby making environment safer. We request you to donate or utilize take back scheme for your electronic good when it reaches its end-of-life, so that it can be reuse-recycle and reinvent.

"Hazard of e waste on environment and Human Health :-

The informal method of recycling extends health hazards. Primary and secondary exposure to toxic metals, such as lead, results in diseases like Heart, Liver, Lung & Spleen Damage. Open-air burning of electronic waste, used

to retrieve valuable components such as gold, not only causes damages to environment but also to human health. Incineration from burning e-waste creates fine particulate matter, which is linked to heart and respiratory disease. However the above said is only example and the informal way to recycle causes numerous health hazards. During such informal recycling no caution or care are kept to either secure the environment or human health. The informal method of recycling extended environment hazards too. For example when different e-waste is burnt to extract metals from it, toxic chemicals are released in to the air, damaging the atmosphere. Such informal ways creates noise, water and air pollution.

E WASTE TOXIC COMPONENT & THEIR DAMAGE TO HUMAN HEALTH

Toxic Materials	Birth Defects	Brain Damage	Heart, Liver, Lung & Spleen Damage	Kidney Damage	Nervous/ Reproductive System Damage	Skeletal System Damage
Barium	✓	✗	✗	✓	✓	✓
Cadmium	✗	✓	✗	✗	✗	✗
Lead	✗	✗	✓	✗	✗	✓
Lithium	✗	✗	✗	✗	✗	✓
Mercury	✗	✗	✗	✗	✓	✓
Nickel	✗	✓	✗	✗	✗	✓
Palladium	✗	✗	✗	✗	✓	✓
Rhodium	✓	✓	✗	✓	✓	✓
Silver	✗	✗	✗	✗	✗	✓

Without safe recycling, most of these toxic components will end in land fill-poisoning soil and water

Why proper handling and management of e-waste :-

The electrical and electronic equipment (EEE) have valuable materials and hazardous/toxic substances in their components. The electronic products and electrical equipment after their useful life may not cause any harm if it is stored safely in households/stores. However, if the E-waste is opened-up and attempts are made for retrieval of useful components or material in an un-scientific manner or if the material is disposed in open, then it may cause health risks and damage to environment. E-waste can be considered as a resource that contains useful material of economic benefit for recovery of plastics, iron, glass, aluminum, copper and precious metals such as silver, gold, platinum, and palladium and lead, cadmium, mercury etc. However, at the same time presence of heavy metals (As, Cd, Hg, Pb etc.) and other toxic substances such as polychlorinated biphenyls (PCBs), etched chemicals, etc. may pose risk to health and environment during handling and recovery operations. E-waste is a problem of increasing proportions especially when crude methods are adopted for recovery of useful components from E-waste.

Thus, there is a need to encourage OUR SELF for recycling of all useful and valuable material from e-waste so as to conserve the ever depleting natural resources. Electronic component are increasingly made from recycled materials, for example for making new LCDs, more than 50% of indium is sourced by recycling used LCDs. The E-waste thus presents a scenario of urban mining for recovery of ferrous/non-ferrous/ rare earth metal and precious metal in addition to plastics and glass. However, presence of hazardous and toxic substances in the component of e-waste necessitates environmentally sound management of e-waste including collection and recycling/treatment in an environmentally sound manner.

Management and Effect on sustainable future:-

Sustainable development as defined by Brundtland Commission is "development that meets the needs of the present without compromising the ability of future generations to meet their own needs."

The e-waste since a long time had been seen as an easy and cheapest source of metals. However due to lack of proper consideration for such source of metals as well as proper methods of recycling in India, we sent our e-waste to the improper channel/scrap vendor and thereby participated in degrading the environment. Moreover, through this improper method of extraction of metals we till date had wasted approximately 40% of the precious metals and simultaneously caused damage to our environment. If we opt the proper way to extract metals through proper channel of recycling then we can achieve approximately 90% of extraction rate of our metals as well as a better way to save our environment. However, if today while selling off our material to improper channel we will not think about our sustainable future then it is for sure that the coming generations will be facing crisis of the metals.

Customer responsibility

- consumers shall ensure that their end of life product's waste is channelized through collection center or dealer of authorized producer or dismantler or recycler or through the designated take back service provider of the producer to authorized dismantler or recycler.
- consumers shall ensure that such end-of-life electrical and electronic equipment are not admixed with e-waste containing radioactive material;

Electronic Waste Recycling:

Do's

- Handover/Donate/Give the discarded Electronic Equipment's only at the authorized collection centers.
- Drop the discarded Electronic Equipment's only in the bins meant for the Electronic Waste.
- Ask the retailer about the Take Back schemes.
- Consult the authorized service center as to whether the Electronic Equipment can be repaired or not, before discarding the same.
- Tell your neighbors and other persons about the hazards of improper disposal or handling or improper recycling of the Electronic Waste.
- If the unwanted Electronic Equipment still work or can be repaired then consider donating them.
- To minimize our impact on the earth and to protect the environment for future generations return your discarded Electronic Equipment's here for safe recycling:

Don'ts

- Don't dump the discarded Electronic Equipment's in open or in any Land Fill Site as the same will result in contaminating the Soil and the ground water.
- Don't dispose of the discarded Electronic Equipment's in household bins or Municipal Bins.
- Don't sell or give your discarded Electronic Equipment's to any Trash Dealer or Kabadiwala/unauthorized vendor.
- Don't try to open up the product by yourself for repair or other purposes.
- Don't mix the electronic waste into household waste stream.
- Don't keep any replaced spare part(s) from the product in exposed area. Always handover such article to service personal so that same can be recycled.

Haier Appliances (India) Pvt. Ltd.

Building No. 1, Okhla Industrial Estate,

Phase III, New Delhi -110020

or Call us at

Toll Free No. (24X7) : 1800-419-9999, 1800-102-9999

